

Date:

Client:

Project:

VOLA product: 4311



**4311**

Build-in basin tap with on-off sensor for 'hands free' operation. For vertical mounting. Sensor aligned with wall. Valve box VR2617 included. 4311UP = Valve 4300, sensor cable VR509. 4311AP = 160 mm spout 010, sensor VR510, 60 mm circular flanges 001, VR512.

Ada approved.

**Flow**

	Bar:	1.0	2.0	3.0	4.0	5.0
4311	(l/min)	2.9	4.1	5.0	5.0	5.0
4311 <sup>1)</sup>	(l/min)	2.6	3.7	4.5	4.5	4.5

<sup>1)</sup> USA Standard

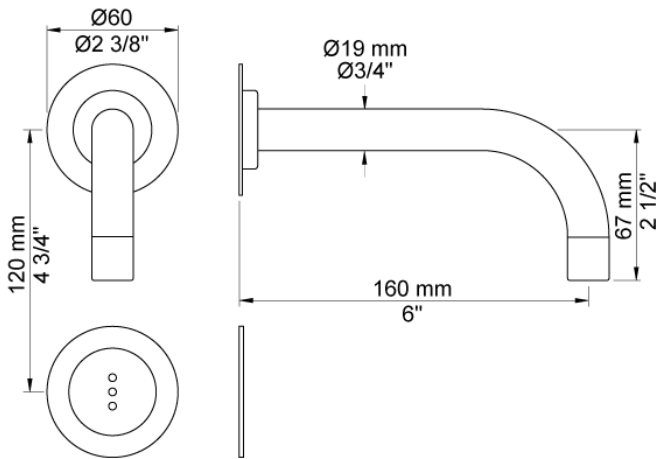

**Available in colors**

- Color 02, Grey
- Color 04, Light blue
- Color 05, Orange
- Color 06, Light green
- Color 08, Yellow
- Color 09, Dark grey
- Color 12, Mocca
- Color 14, Bright red
- Color 15, Dark blue
- Color 16, Polished chrome
- Color 17, Gloss black
- Color 18, White
- Color 19, Natural brass
- Color 20, Brushed chrome
- Color 21, Carmine red
- Color 25, Pink
- Color 27, Matt black
- Color 40, Brushed stainless steel



Date:

Client:

Project:



**001**  
60 mm circular flange. Hole Ø33 mm.

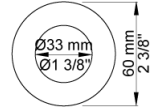

**010**  
160 mm fixed spout with water saving aerator.

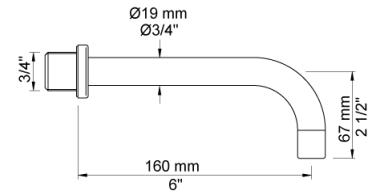

**4300**  
Build-in valve with on-off sensor for 'hands free' operation. Valve box for electronic mixer, VR2617 enclosed.

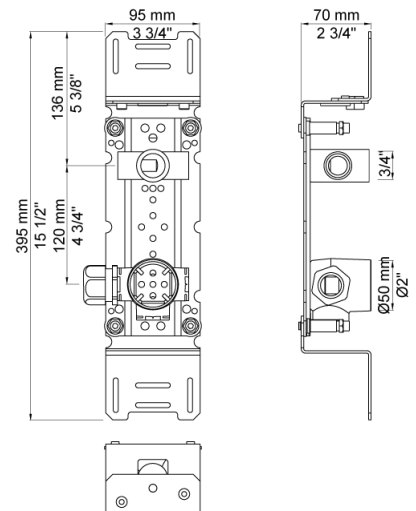

Date:

Client:

Project:

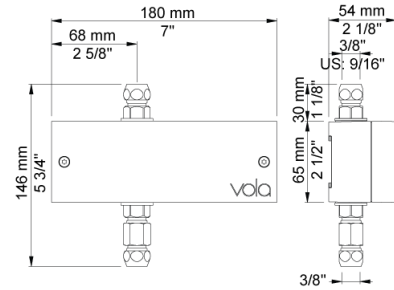

**VR2617**

Valve box for electronic RB1E/4000/4300/4800

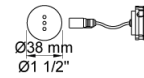
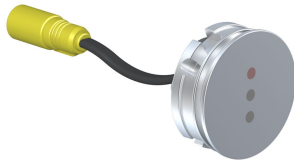

**VR510**

Sensor for electronic tap 4300, 4800 and 4900.

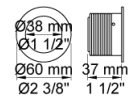
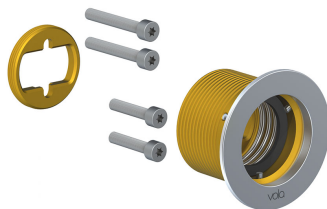

**VR512**

60 mm circular flange. Hole Ø38 mm for 4300, 4800 and 4900.