

Date:

Client:

Project:

VOLA product: 5471S

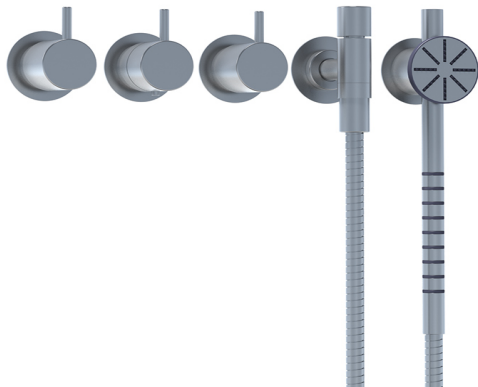

**5471S**

¾" thermostatic mixer. 5471SUP = Thermostatic mixer 5400NV.  
 5471SAP = Handle NR51, handle NR52, handle NR64G, hand shower and hand shower holder with non-return valve 070S, hose 1500 mm, 3 pcs. 60 mm circular flanges 2001, 2 pcs. 001.

**Flow**

	Bar:	1.0	2.0	3.0	4.0	5.0
5471S <sup>1)</sup>	(l/min)	6.9	9.8	12.0	13.9	15.5
5400NV	(l/min)	18.5	26.1	32.0	37.0	41.3

<sup>1)</sup> USA: Flow restricted to 2 gpm (7.6 l/min)

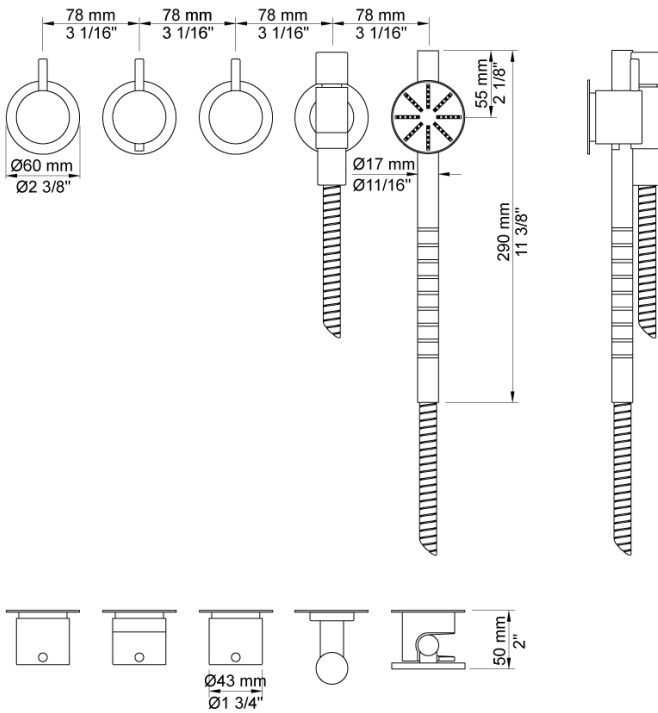

**Available in colors**

- Color 02, Grey
- Color 04, Light blue
- Color 05, Orange
- Color 06, Light green
- Color 08, Yellow
- Color 09, Dark grey
- Color 12, Mocca
- Color 14, Bright red
- Color 15, Dark blue
- Color 16, Polished chrome
- Color 17, Gloss black
- Color 18, White
- Color 19, Natural brass
- Color 20, Brushed chrome
- Color 21, Carmine red
- Color 25, Pink
- Color 27, Matt black
- Color 40, Brushed stainless steel

Date:

Client:

Project:

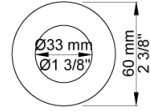
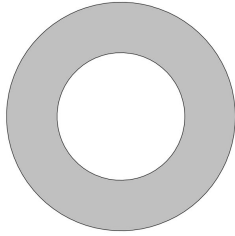

**001**  
60 mm circular flange. Hole Ø33 mm.

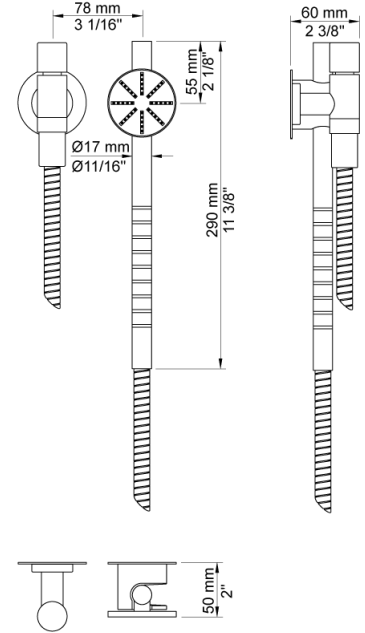

**070S**  
Hand shower, hand shower holder and hose with non-return valve.

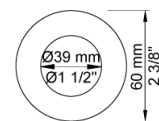

**2001**  
60 mm circular flange. Hole Ø39 mm.

Date:

Client:

Project:

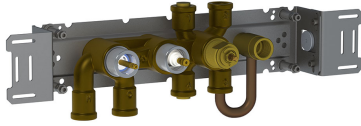

**5400NV**

Thermostatic mixer with diverter and one fixed outlet socket. 3/4" connection to copper, steel, iron or pex pipe work.

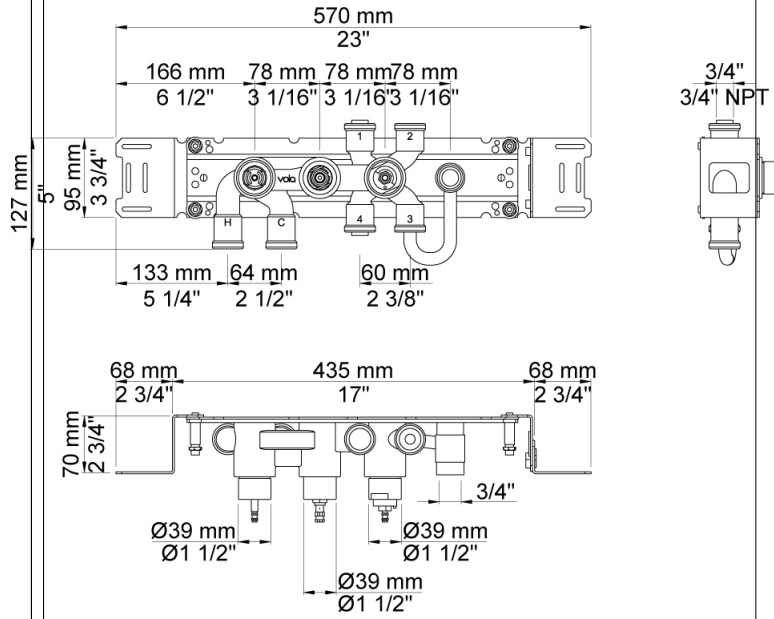

**NR51**

On/off handle for 5000 and 6000.

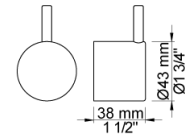

**NR52**

Thermostatic handle for serie 5000.

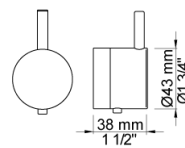

Date:

Client:

Project:

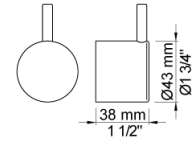

**NR64G**

Diverter handle for 5400/5600. With peg in the same colour as handle (Standard).