

Date:

Client:

Project:

VOLA product: 5474R-081ST

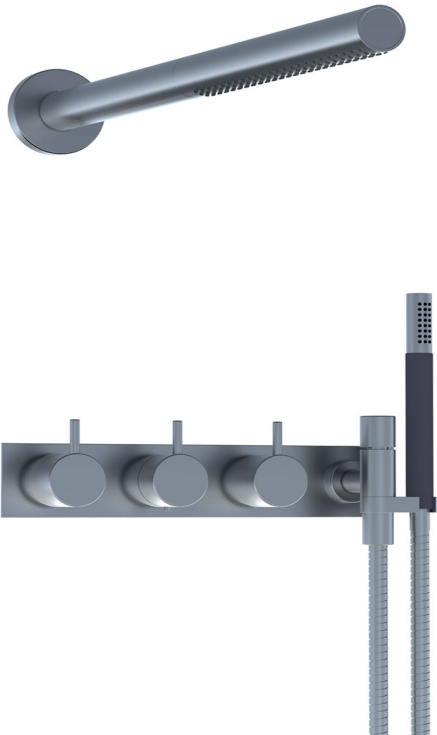

5474R-081ST

¾" thermostatic mixer.5474R-081STUP = Thermostatic mixer 5400NV, 200M.5474R-081STAP = Handle NR51, handle NR52, handle NR64G, hand shower and hand shower holder with non-return valve 070R, hose 1500 mm, head shower 080ST, four-hole plate 5004B, 60 mm circular flange 001.

Flow

	Bar:	1.0	2.0	3.0	4.0	5.0
070R ¹⁾	(l/min)	5.2	7.4	9.0	9.0	9.0

¹⁾ USA: Flow restricted to 1.8 gpm (7.0 l/min)

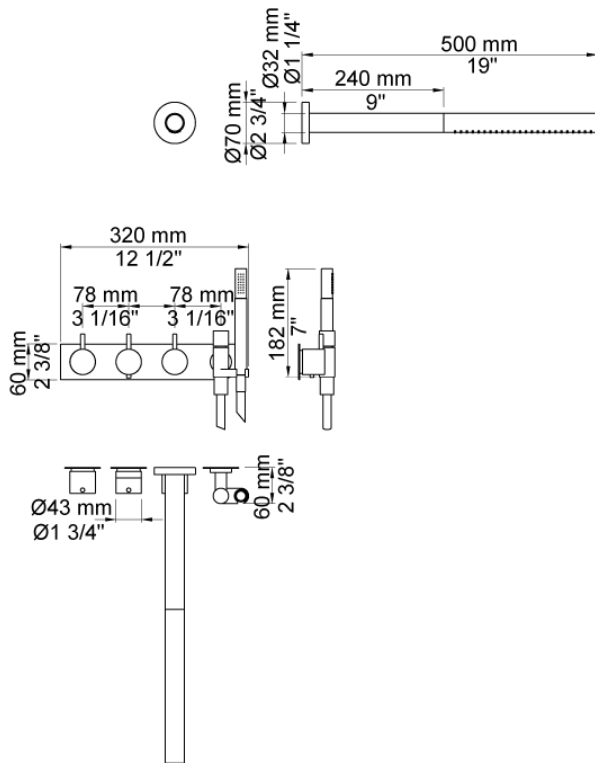

Available in colors

- Color 02, Grey
- Color 04, Light blue
- Color 05, Orange
- Color 06, Light green
- Color 08, Yellow
- Color 09, Dark grey
- Color 12, Mocca
- Color 14, Bright red
- Color 15, Dark blue
- Color 16, Polished chrome
- Color 17, Gloss black
- Color 18, White
- Color 19, Natural brass
- Color 20, Brushed chrome
- Color 21, Carmine red
- Color 25, Pink
- Color 27, Matt black
- Color 40, Brushed stainless steel

Date:

Client:

Project:



070R

Hand shower, hand shower with holder to the right and hose with non-return valve.

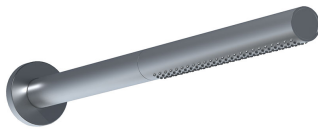
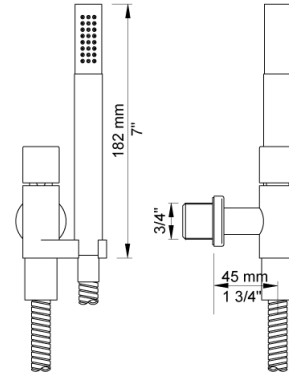

080ST

Head shower, 500 mm.

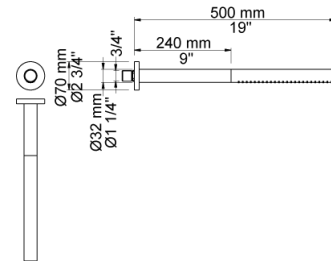

5004B

Four-hole plate (for 5400, 5400N and 5400NV). 60 x 309 mm. Holes Ø39, Ø39, Ø39 and Ø33 mm.

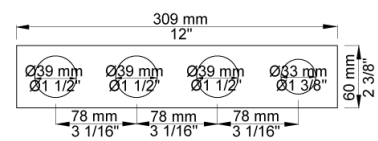

Date:

Client:

Project:

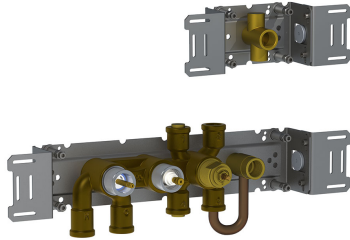

5400N

Thermostatic mixer with diverter and fixed outlet socket and one separate outlet socket, 200M. 3/4" connection to copper, steel, iron or pex pipe work.

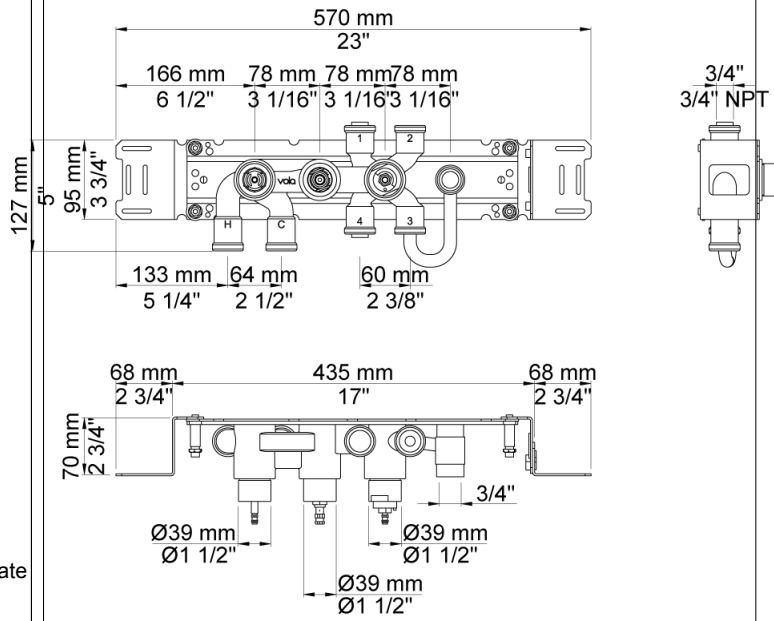

NR51

On/off handle for 5000 and 6000.

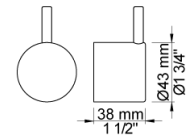

NR52

Thermostatic handle for serie 5000.

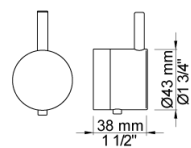

Date:

Client:

Project:

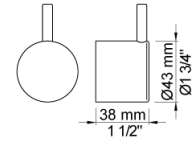

NR64G

Diverter handle for 5400/5600. With peg in the same colour as handle (Standard).